



# 深圳富明精密工业有限公司

Shenzhen Forman Precision Industry Co.,Ltd.

**Our Core Value:**  
Customer-centric,  
Contributor-Oriented,  
Always try our best!





## About us

Shenzhen Forman Precision Industry Co., LTD is a leading and experienced manufacturing vendor, dedicated to the development of metal and plastic parts. For over 20 years, we have specialized in the design and production of connectors and cables. Our market spans the automotive, new energy, industrial automation, and medical devices sectors.

We are certified by ISO 9001, ISO 14001, IATF 16949, and ISO 13485, and we are also a member of the USB Association, with UL and TUV certifications.

Our goal is to provide a unique service experience and add value for our customers through end-to-end management. We take pride in our reputation for being fast, flexible, and customer-focused.





## Our core values

- **Customer-centric**

Understanding and meeting customer need is our company's duty. We continuously improve our product research and development, manu-facturing processes, and management capabilities to better serve our customers and maintain an unbeatable position in the competition.

- **Contributor-oriented**

Strive to optimize our company's various management and incentive systems, so that contributors who can better serve customers and continuously improve the company's capabilities can receive better respect and welfare benefits.

- **Always try our best**

We always try our best to serve every customer anytime.





## Company Developments

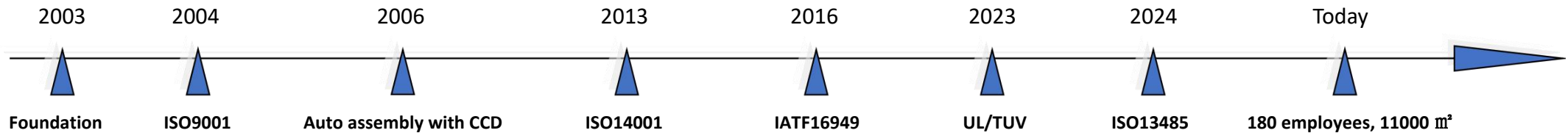
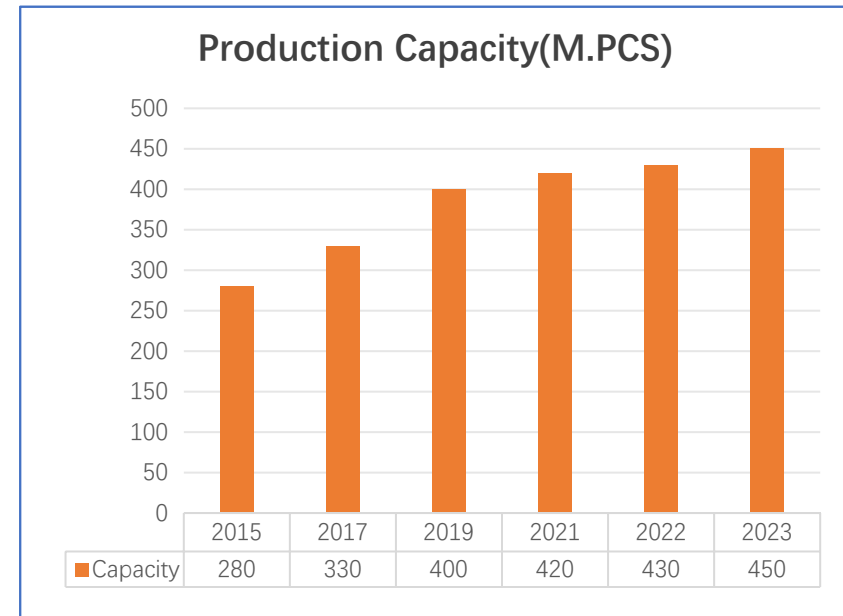
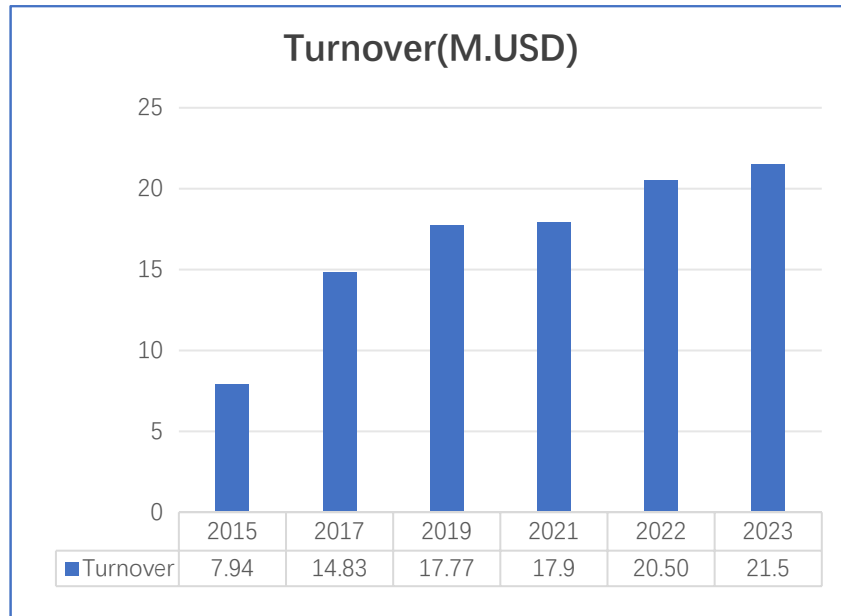





## Product Design and Tooling Development

- Have 15 production/tooling engineers who have more than 10 years professional experience.
- Develop software - PROE, AutoCAD
- Process Validation Tool -APQP, PPAP, FMEA, SPC, MSA
- Develop Simulating software : Part Design, Tooling Design, Rating Testing

Part Design simulation

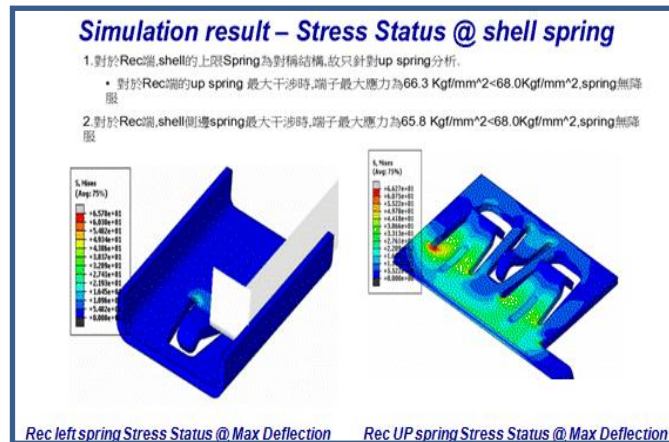

Tooling design simulation

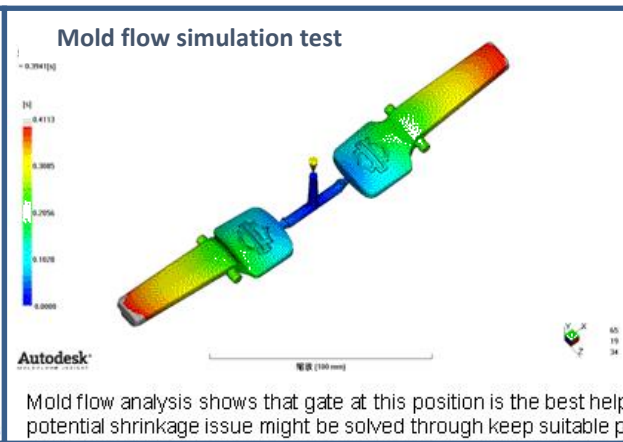

Rating test simulation

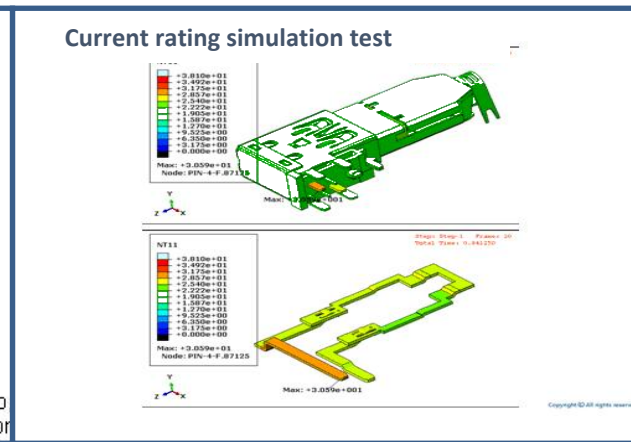



## Workshops & Equipments





## Workshops & Equipments

### Machine List

#### Exsiting machines of tooling workshop

Name	Model	Brand	QTY	Name	Model	Brand	QTY
WEDM	M50B	SeiBu(Japan)	1set	Grinder	614S	HYFAIR(TW)	11sets
WEDM	AQ560LS/400L	Sodick	3 sets	Big Grinder	KG-S-306AH	HYFAIR(TW)	2sets
EDM	M30F	ARD	3sets	Grinder	JL614	Zhun Li(TW)	3sets
Wire Cut	H-CUT 40F	Lian Gao (SZ)	3 sets	Grinder	JL614	Yu Qing(TW)	2sets
Milling machine	16SS	KUNMING (TW)	1set				

#### Exsiting machines of stamping workshop

#### Exsiting machines of injection molding workshop

Name	Model	Brand	QTY	Name	Model	Brand	QTY	Name	Model	Brand	QTY
High-speed Stamping	35T~60T	LIDING	8 sets	Horizontal injection molding machine	50T-180T	Taichung(TW)	12 sets	Vertical injection molding machine			
High-speed Stamping	35T~40T	MICRON	13 sets		80T-110T	Nissei(Japan)	8 sets		55T	Kunshan Baisu	9 sets
High-speed Stamping	40T	Japan KYORI	1 sets		30T、300T	Fanuc	2 sets		25T	Zanyang	1 sets
High-speed Stamping	110T	SEYI(TW)	2sets		90T	Zhongtai	2 sets				







## Quality Assurance

Major test and measuring instruments

Electricity



Dimension



Enviroment



Mechanic







## Quality Assurance

### Test and measuring equipments list

Purpose	Description	Model	Brand	Qty	Purpose	Description	Model	Brand	Qty
Mechanics	Metal Strength Testing Device	XM-SFC0002	Xiangmin	1	Dimension	Image Dimension Measuring System	IM7030	Keyence	1
	Microhardness tester	HV-1000	Lianer	2		Tooling Microscope	MM-40	Nikon	1
	Plating and Coating Thickness Tester	XULM XYM	Fischer	1		2D Projector	V-12B	Nikon	1
	Automatic insertion-extraction force tester	MY-1220	Hui Tai	2		Height gauge	MFC-101	Nikon	1
	Insertion-extraction tester	YN70-15	VTV	6		Height gauge	10-C150MXB	Mitutoyo	1
	Drop tester	XD-DY1500	Xiangmin	1		Optical measuring device	VMS-2010G	Wanhao	7
Environment	Salt fog Tester	CZ-60A	Zonzhi	1		2D Projector	CPJ-3015Z	Wanhao	2
	Thermal Shock Chamber	S3-08L-A-3	Sanwood	1		Electricity	Contact impedance tester	HG2511	Hui Gao
	Temperature and Humidity Tester	SH5500	Sanwood	1	Temperature rise Tester		SI-10X	Sunjat	1
	X-Ray Spectrometer	EDX 2800	Tianrui	1	Cable harness tester		CT-8681	Yihe	1
	Horizontal-Vertical flammability tester	XM-HV001	Xiangmin	1	Conductivity Tester		SMP350	Fischer	1





## Our Products

### Energy storage connectors & cables

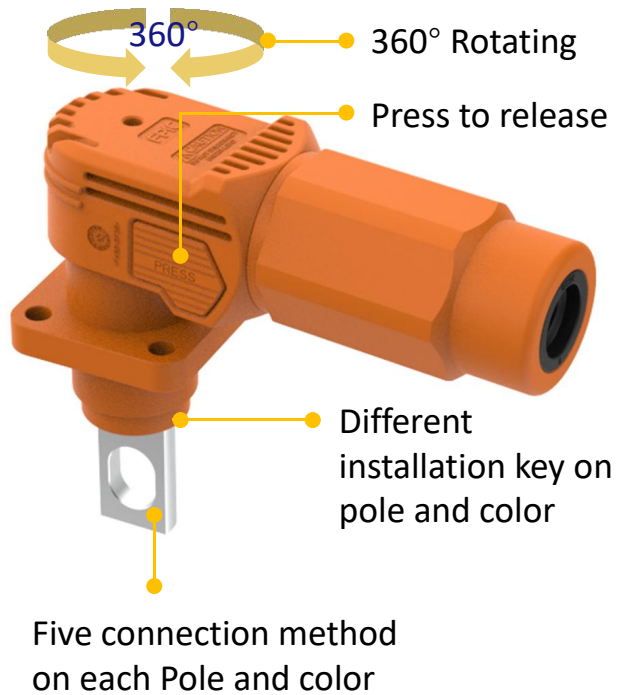

#### Key Features:

- Touch proof, safety, reliability
- 360° rotating plug, conserve space, operational
- efficiencies
- UL 4128 standard
- IP67 waterproof
- Different installation key on receptacles

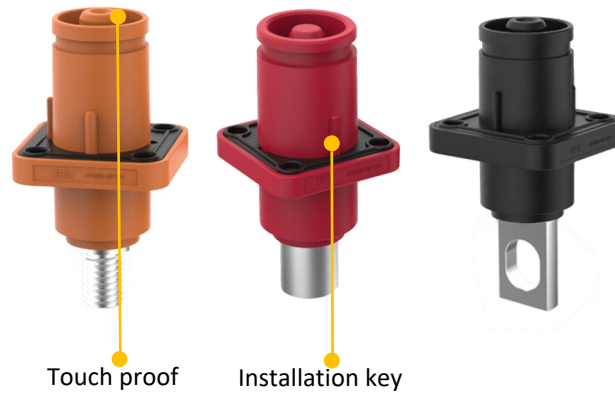

Outer Thread

Copper Bar Inner Thread

Inner Thread

Copper Bar Thorough Hole

Crimping

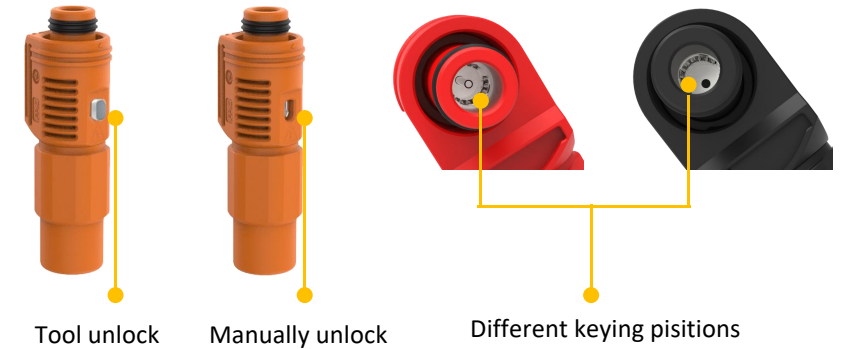



## Our Products

### Solar Connectors & Cables



### Features:

- Easy and quick installation, safe and reliable
- Ergonomic and aesthetically pleasing
- Customizable cable length

### E-Bike Connectors & Cables





## Our Products

### Busbar

#### Features:

- Strong overload capacity
- Compact, simple, and aesthetically pleasing design
- Available processes: molecular diffusion welding, film lamination, spraying, dipping

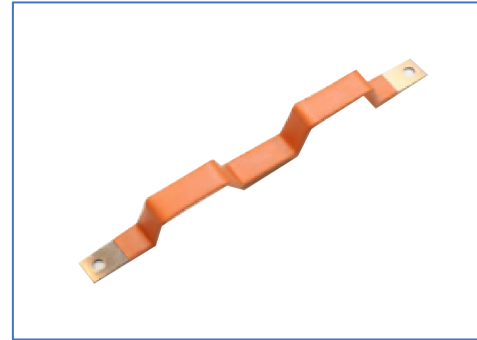

Rigid Busbars

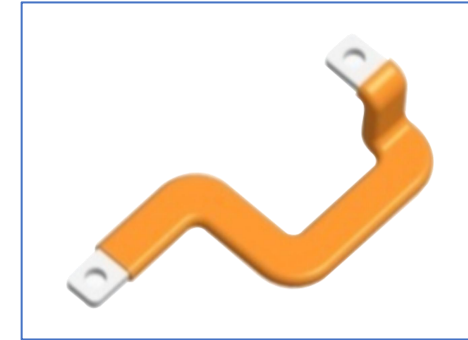

Rigid Busbars



Laminated Busbars



Flexible Busbars







## Our Products

Electric Vehicle HV  
Connectors & Cables

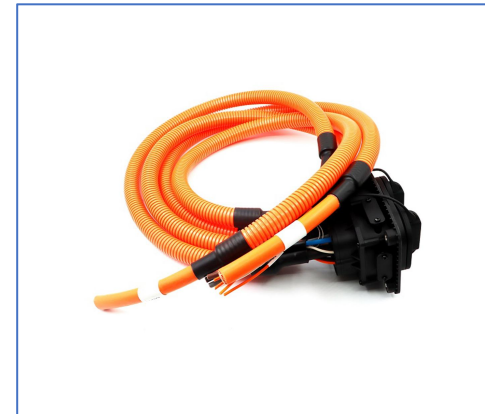



## Our Products

### Automotive connectors

#### Features:

- Compact structure, stable and reliable threaded connection
- Safe and reliable, compliant with IEC standards
- Customizable cable length

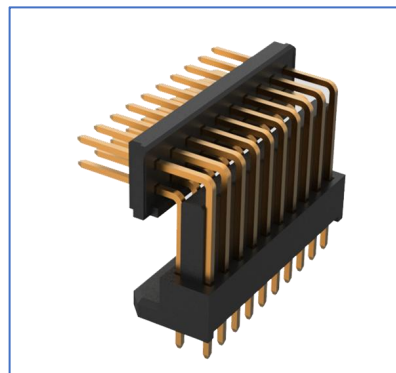
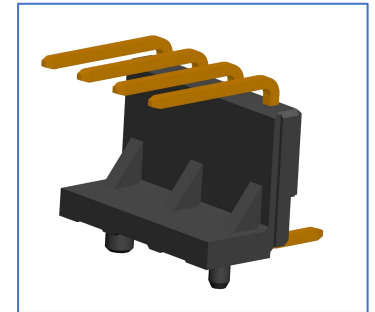
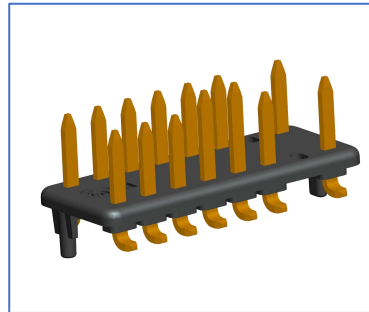



## Our Products

### Circular connectors & cables

#### Features:

- Mechanical life: 500 cycles
- strong vibration resistance
- IP67 waterproof
- 360-degree shielding
- Temperature resistance:  
-40 to 105°C

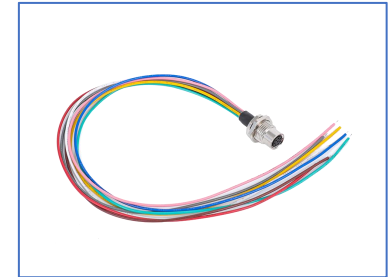
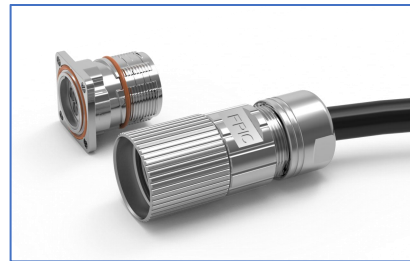



## Our Products

### Industrial Wire Harness

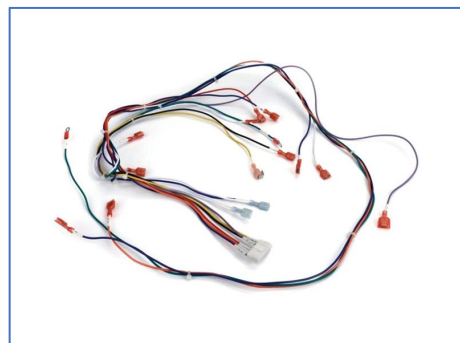





## Our Products

### Medical Wire Harness

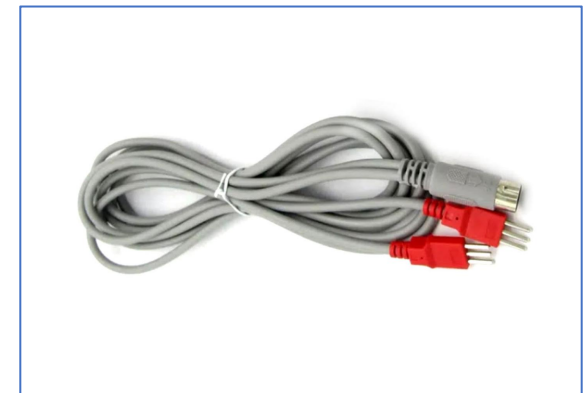
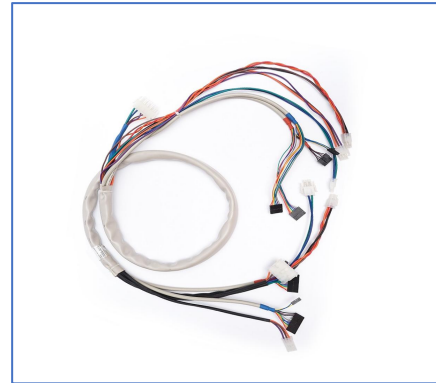



## Our Products

### PCBA connectors

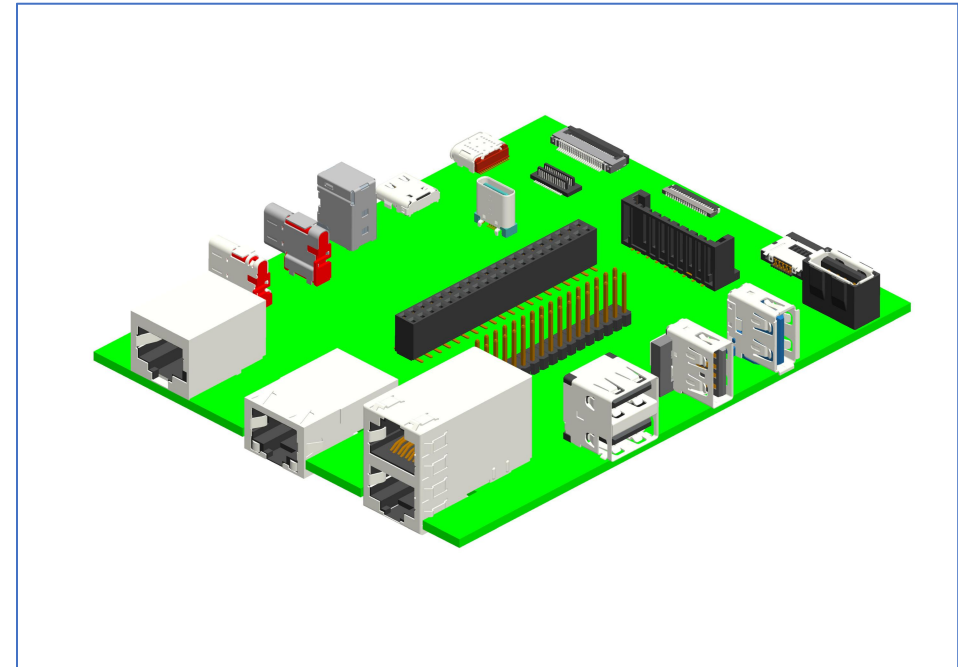
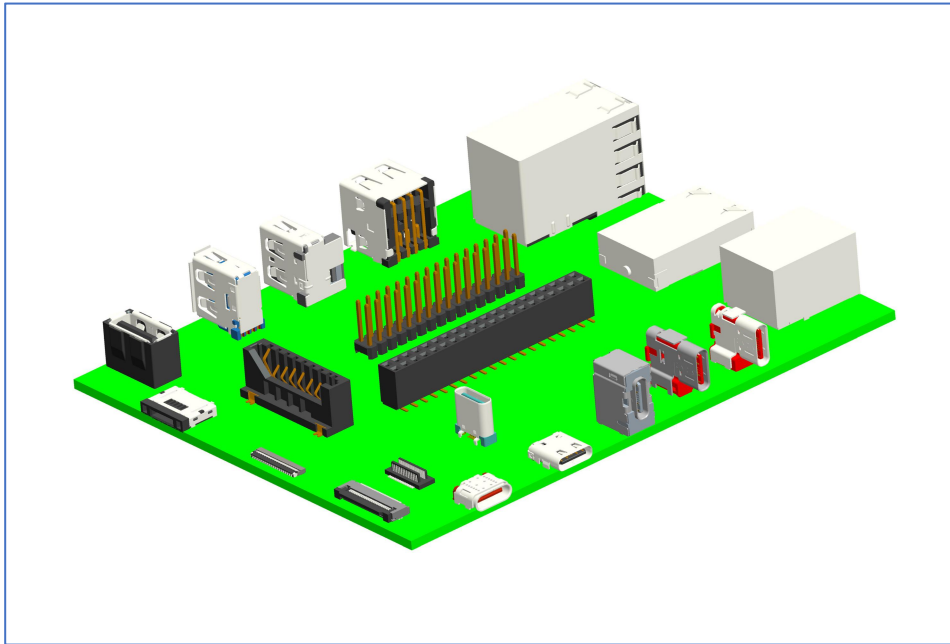



## Our Products

### Metal parts

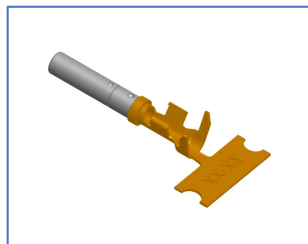

Composite Terminals

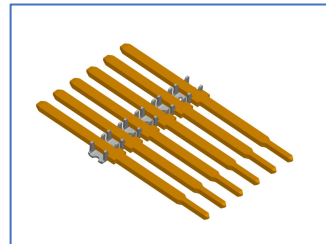

Spring-Clip Terminals--Automotive Standard

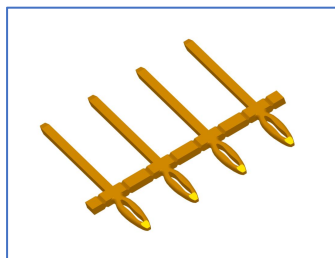
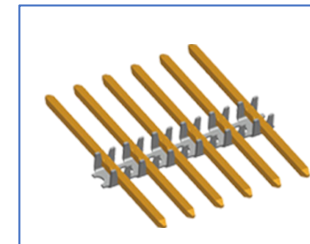

Press Fit Terminals

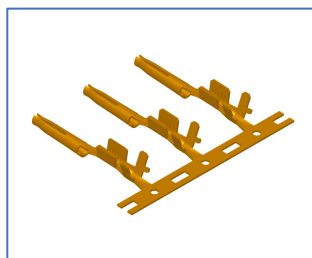

Spring-Clip Terminals

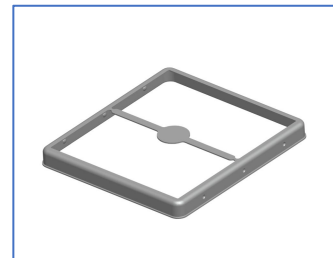

Shielding Covers

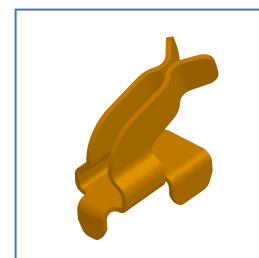

Terminal

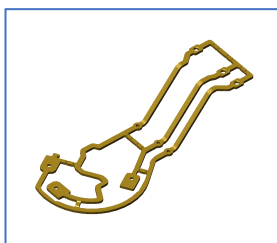

Automotive Terminal

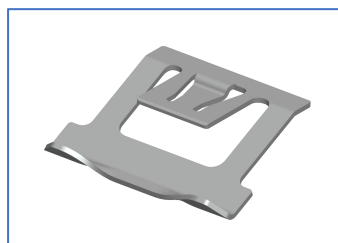

Automotive Clip

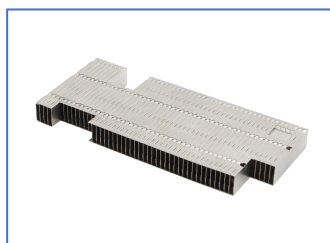

Stamped Fins



Folded Fins





## Our Products

Insert Molding Parts

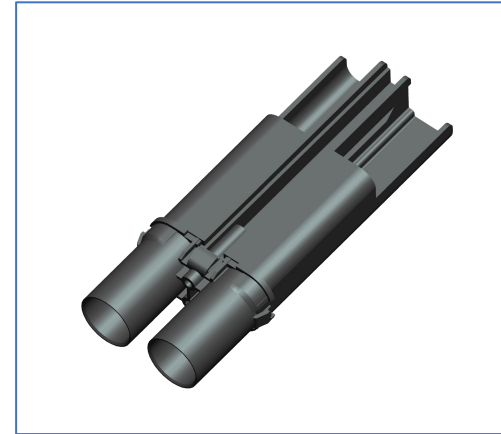
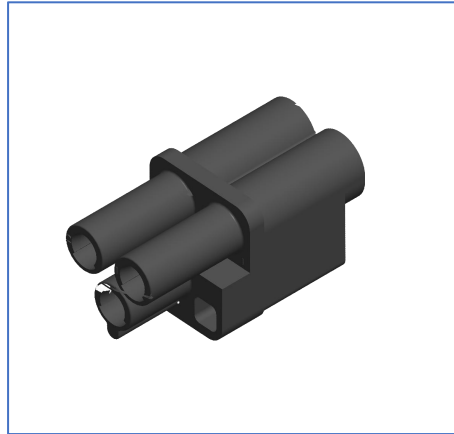





## Our Platforms

Intelligent manufacturing  
operation management platform

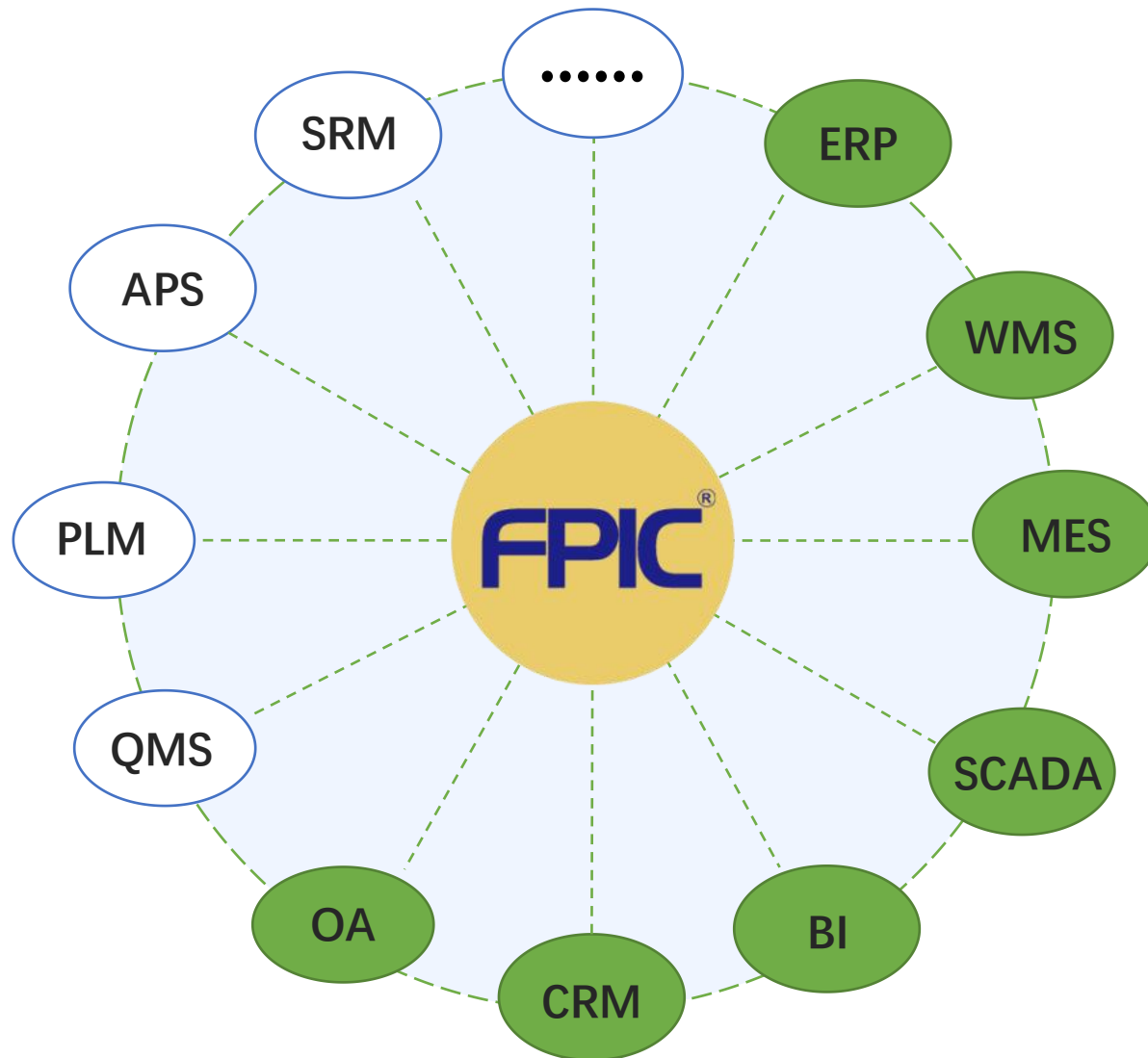



# Certificates

## Meet the Safety Standard of Management System



IATF16949



ISO9001



ISO13485

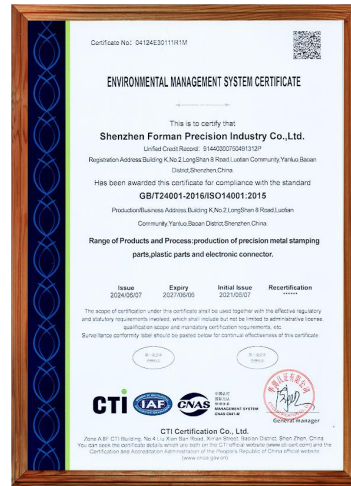

ISO14001



TUV Verified

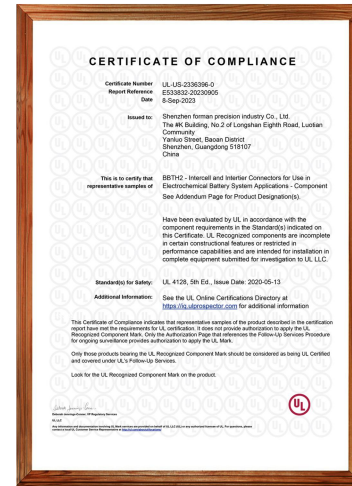

UL Verified



## Our Customers

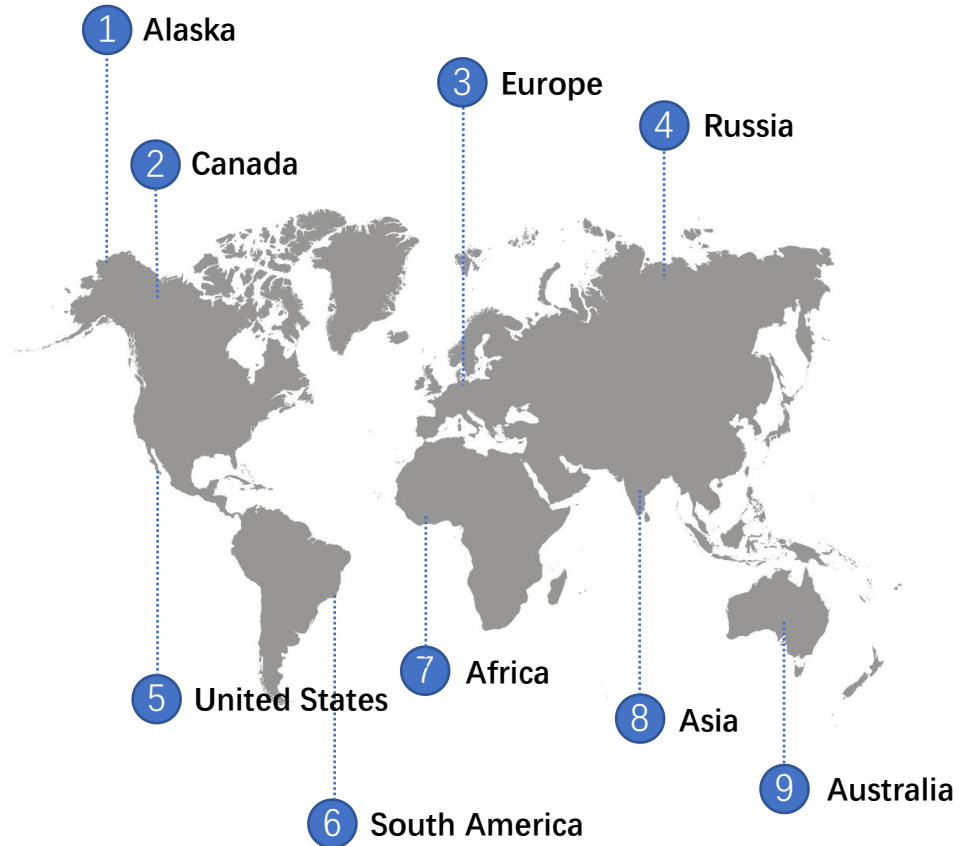



## Our Strengths

- Focusing on the connector and wire harness industry for over 20 years, we are able to provide you with more professional service in this industry.
- We offer end-to-end solutions, including product design, mold design and manufacturing, parts production, automated assembly, testing, and packaging for connectors, wire harnesses, and metal parts.
- The positioning of a small and beautiful enterprise can provide you high quality (vendor of several top brands in the industry), reasonably priced products, and quick response during the service process.
- Zero risk of development promise: we'll refund all development costs to customer, if our company's development work can't meet their requirement.







深圳富明精密工业有限公司  
Shenzhen Forman Precision Industry Co.,Ltd.



**Welcome to visit us!**

**Shenzhen Forman Precision Industry Co., Ltd.**

Building K, No. 2, Longshan Eighth Road, Luotian Community, Yanluo  
Street, Baoan District, Shenzhen City, GD, China.

