



2.54mm Pin Header DIP Type

SPECIFICATION

Current Rating :3.0AMP
Insulation Resistance :1000M Ω MIN.
Contact Resistance :20m Ω MAX.
Withstanding voltage : AC 500V MIN.
Operating Temperature :-40°C to +105°C

Contact Material :Brass
Contact Plating :Gold or Tin over Nickel
Insulation Material :PBT+30%G.F UL94V-0
Color :Black

AMF25 **X** **N** - **D** **01** - **XX** **XX** **X** **X**

Row Type:
 1=Single Row
 2=Double Row

Specify LEAD STYLE from chart.

No.of Pins Per Row: 02 thru 40

Contact Plating:
 G1=Full gold flash G3=Full gold 3u"
 G5=Full gold 5u" G6=Full gold 10u"
 G7=Full gold 15u" G8=Full gold 30u"
 K1=Gold flash on contact, Tin 100u" on tail
 K5=Gold 5u" on contact, Tin 100u" on tail
 K6=Gold 15u" on contact, Tin 100u" on tail
 K8=Gold 30u" on contact, Tin 100u" on tail
 S1=Full Tin 100u"

Insulation Material:
 B=PBT
 D=LCP
 F=PA9T
 H=PA6T

Packing:
 Y=Tray
 T=Tube
 P=PE Bag

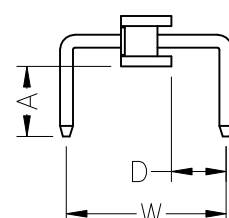
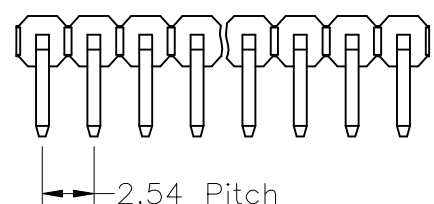
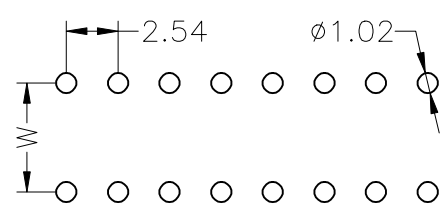

AMF251N-D01

LEAD STYLE	Dim W	Dim A	Dim D
01	5.50	3.60	1.20
02
...			

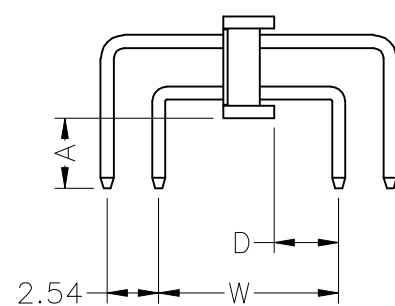
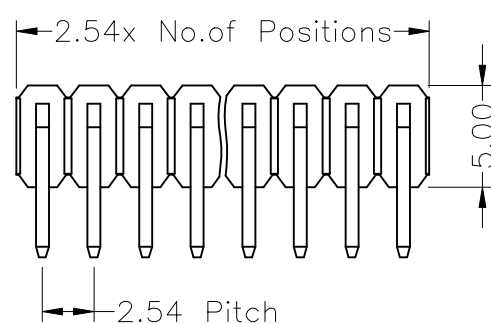
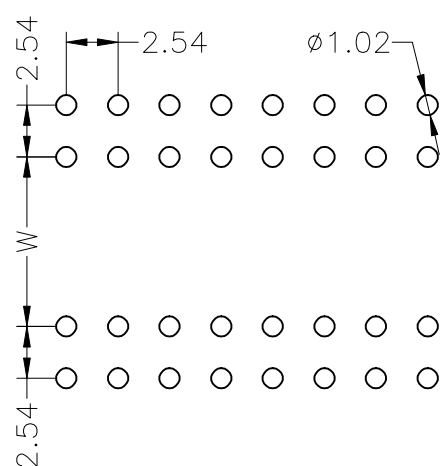
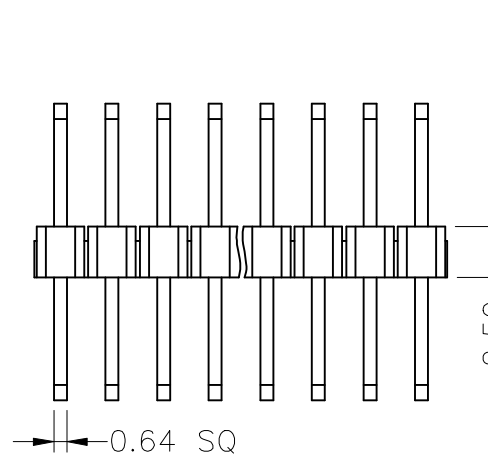

AMF252N-D01

LEAD STYLE	Dim W	Dim A	Dim D
01	5.50	3.60	1.20
02
...			